

**LGB** documents provided courtesy of:

**TRAINLI**

You can find everything you need for your hobby at

[Click Here >>>](#) [www.trainli.com](http://www.trainli.com)

+1 (775) 302-8111

[like us on Facebook](#)

<https://www.facebook.com/trainlipage/>



# SERVICE

## Weitere Informationen

erhalten Sie von Ihrem autorisierten LGB-Händler und bei

Ernst Paul Lehmann Patentwerk  
Saganer Strasse 1-5  
D-90475 Nürnberg  
DEUTSCHLAND  
Tel.: (0911) 83707 0  
Fax: (0911) 83707 70  
www.lgb.de

**Achtung!** Geben Sie bei der Bestellung eines Ersatzteils bitte die Nummer der Zeichnung oben auf dieser Seite (z. B. "2019S-1") und die Nummer des Teils auf der Zeichnung (z. B. "15") an.

**Achtung!** Produkte und technische Daten können sich ohne Vorankündigung ändern.

LGB, LGB of America, LEHMANN und der LGB TOYTRAIN-Schriftzug sind eingetragene Marken der Firma Ernst Paul Lehmann Patentwerk, Nürnberg, Deutschland. Andere Marken sind ebenfalls geschützt. © 2002 Ernst Paul Lehmann Patentwerk.

## For more information,

contact your authorized LGB retailer or:

*in North America*

LGB of America  
6444 Nancy Ridge Drive  
San Diego, CA 92121  
Telephone: (858) 795-0700  
Fax: (858) 795-0780  
USA  
www.lgb.com

*in all other areas*

Ernst Paul Lehmann Patentwerk  
Saganer Strasse 1-5  
D-90475 Nürnberg  
Telephone: (0911) 83707 0  
Fax: (0911) 83707 70  
GERMANY  
www.lgb.de

**Attention!** When ordering a part, please include the drawing number at the top of this page (e.g., "2019S-1") and the number of the part in the drawing (e.g., "15").

**Attention!** Products and specifications are subject to change without notice.

LGB, LGB of America, LEHMANN and the LGB TOYTRAIN logo-type are registered trademarks of Ernst Paul Lehmann Patentwerk, Germany. Other trademarks are the property of their owners. © 2002 Ernst Paul Lehmann Patentwerk.

20892

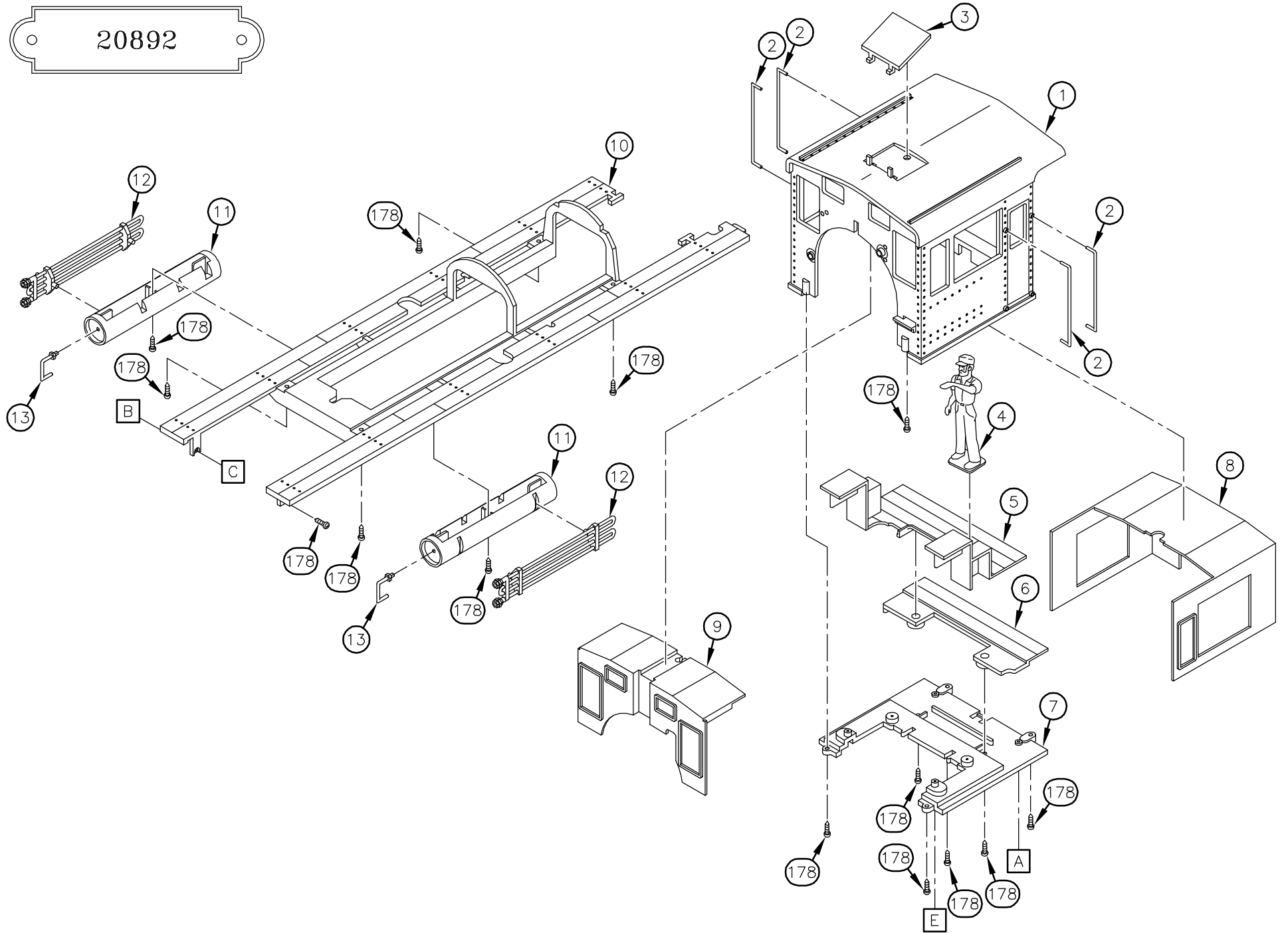

20892

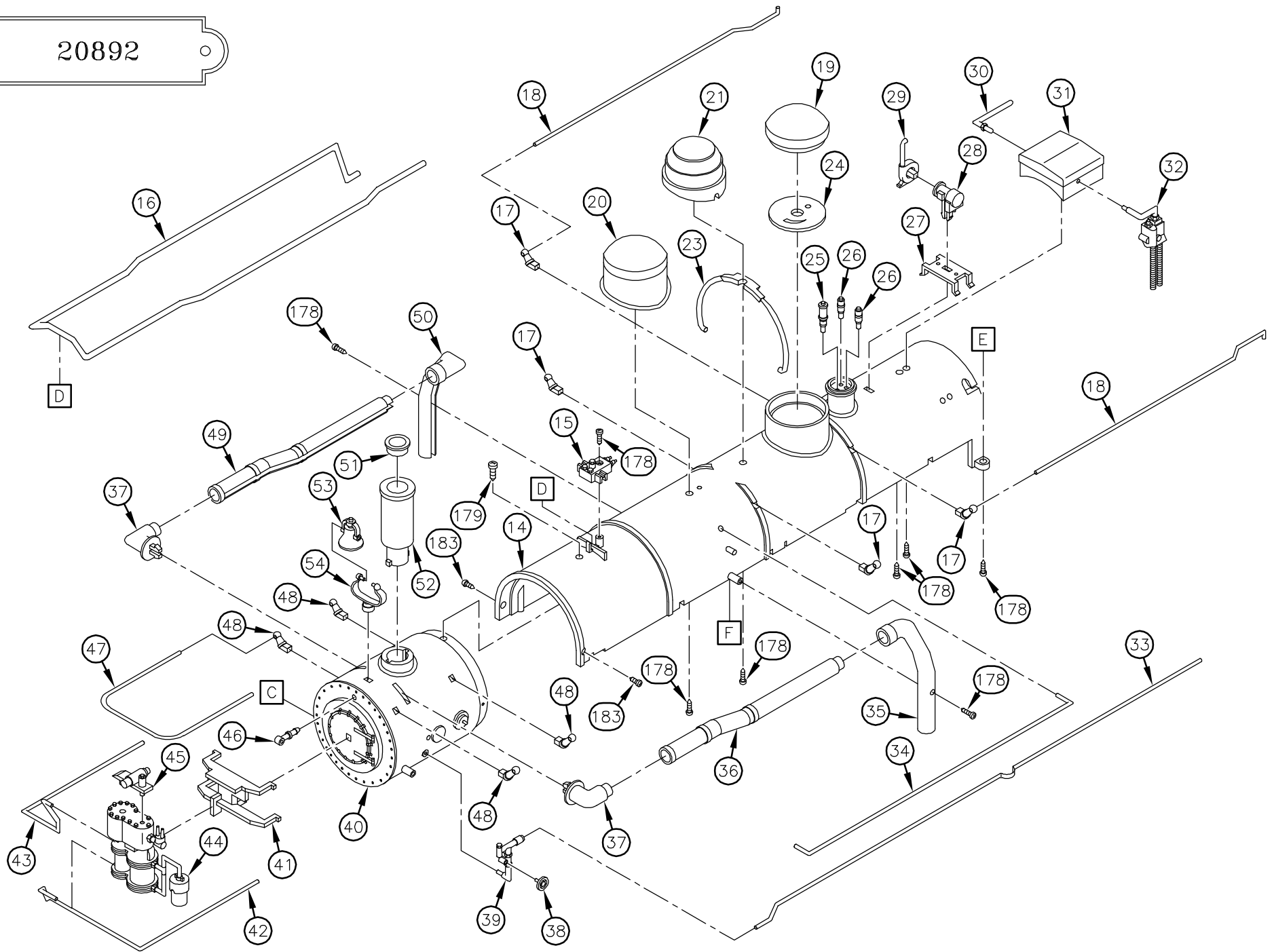

20892

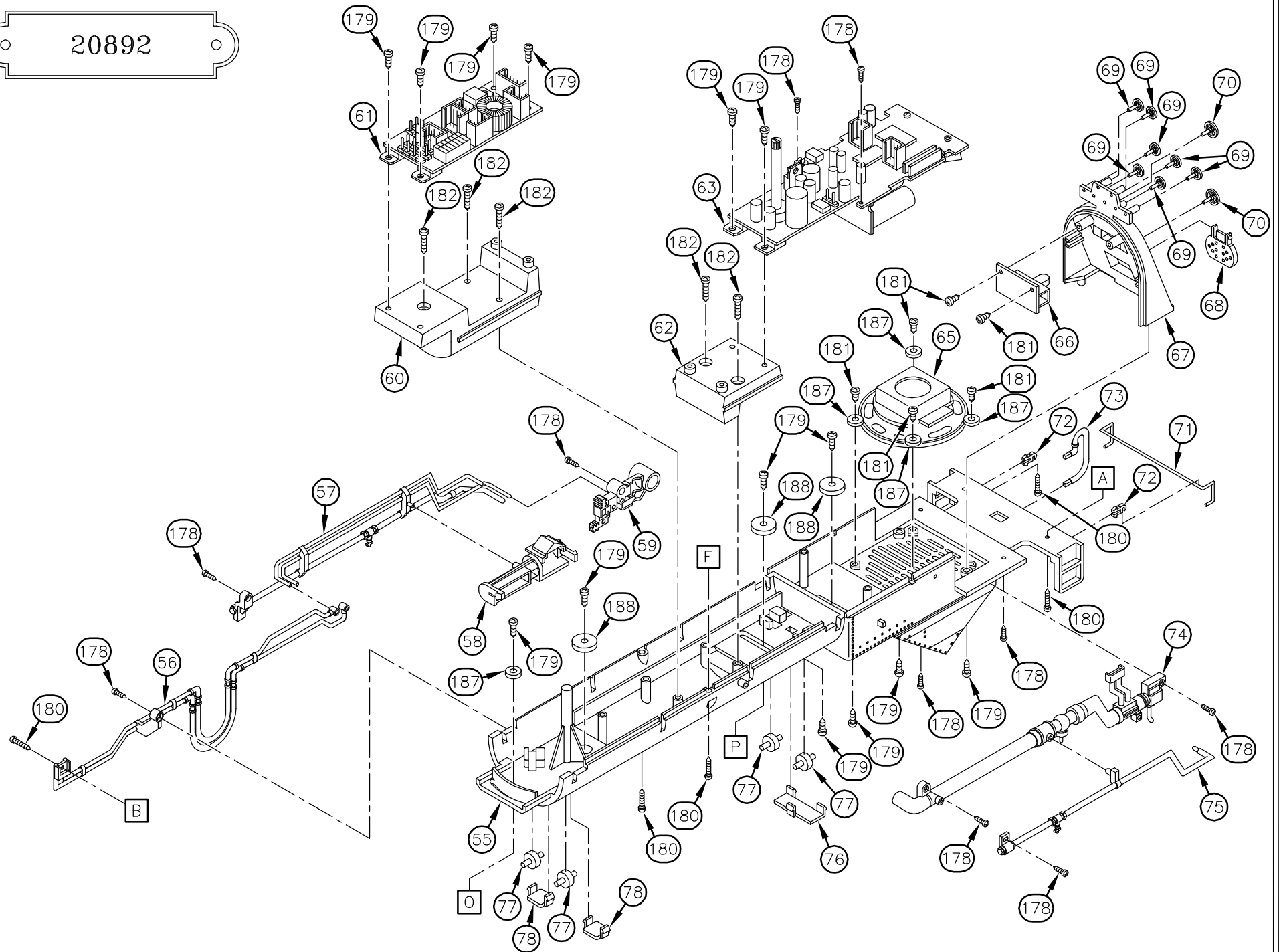

20892

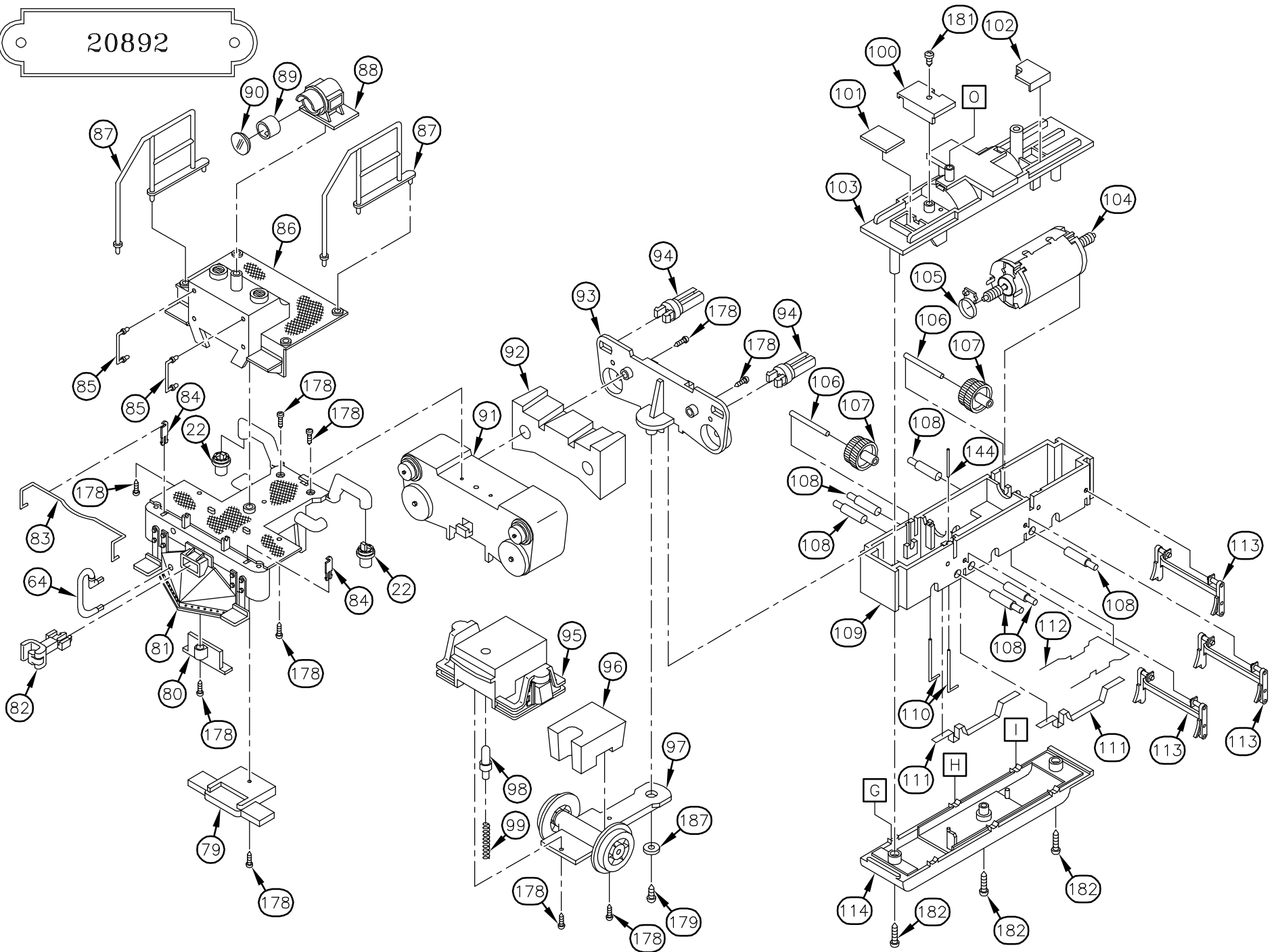

20892

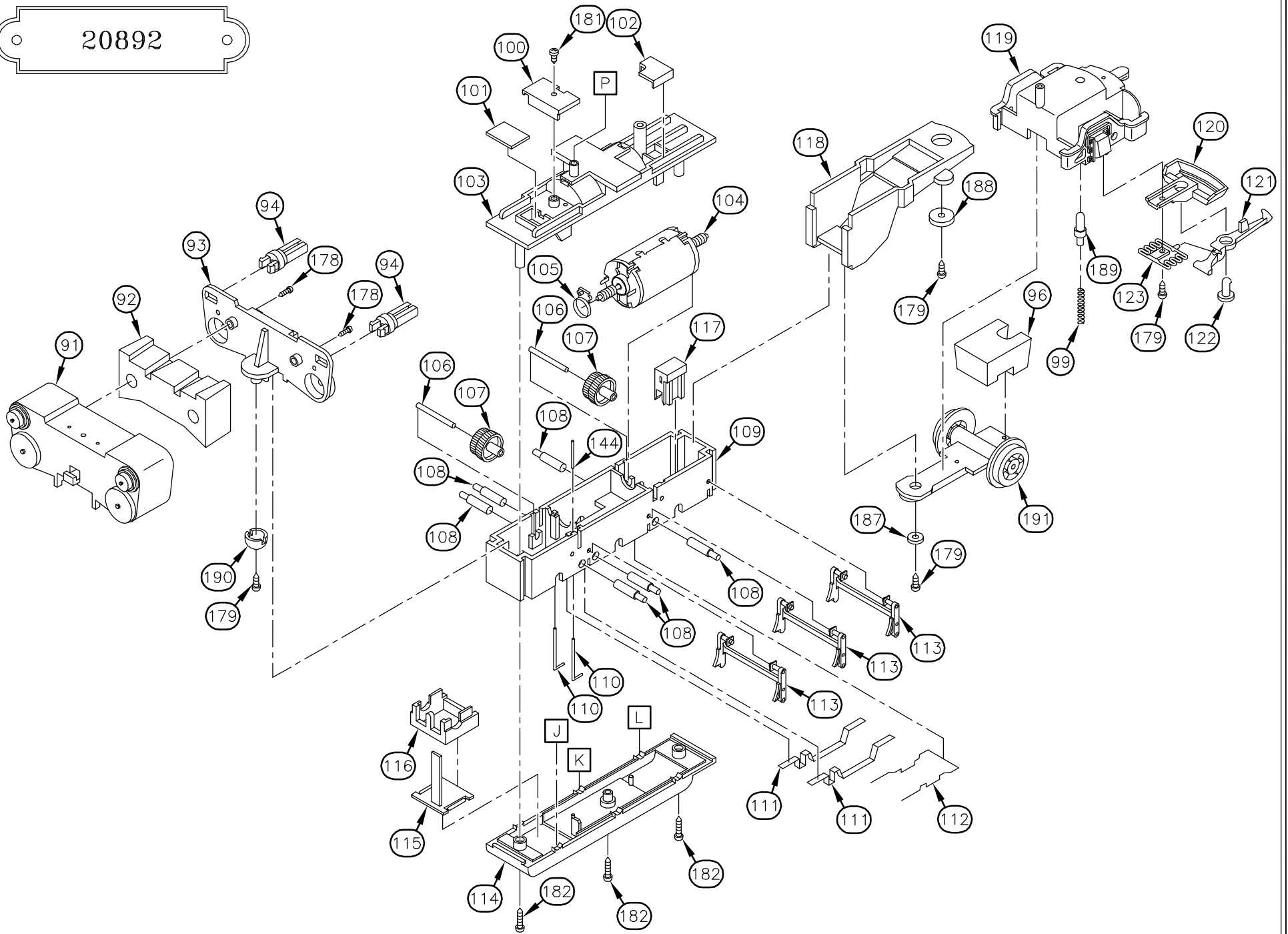

20892

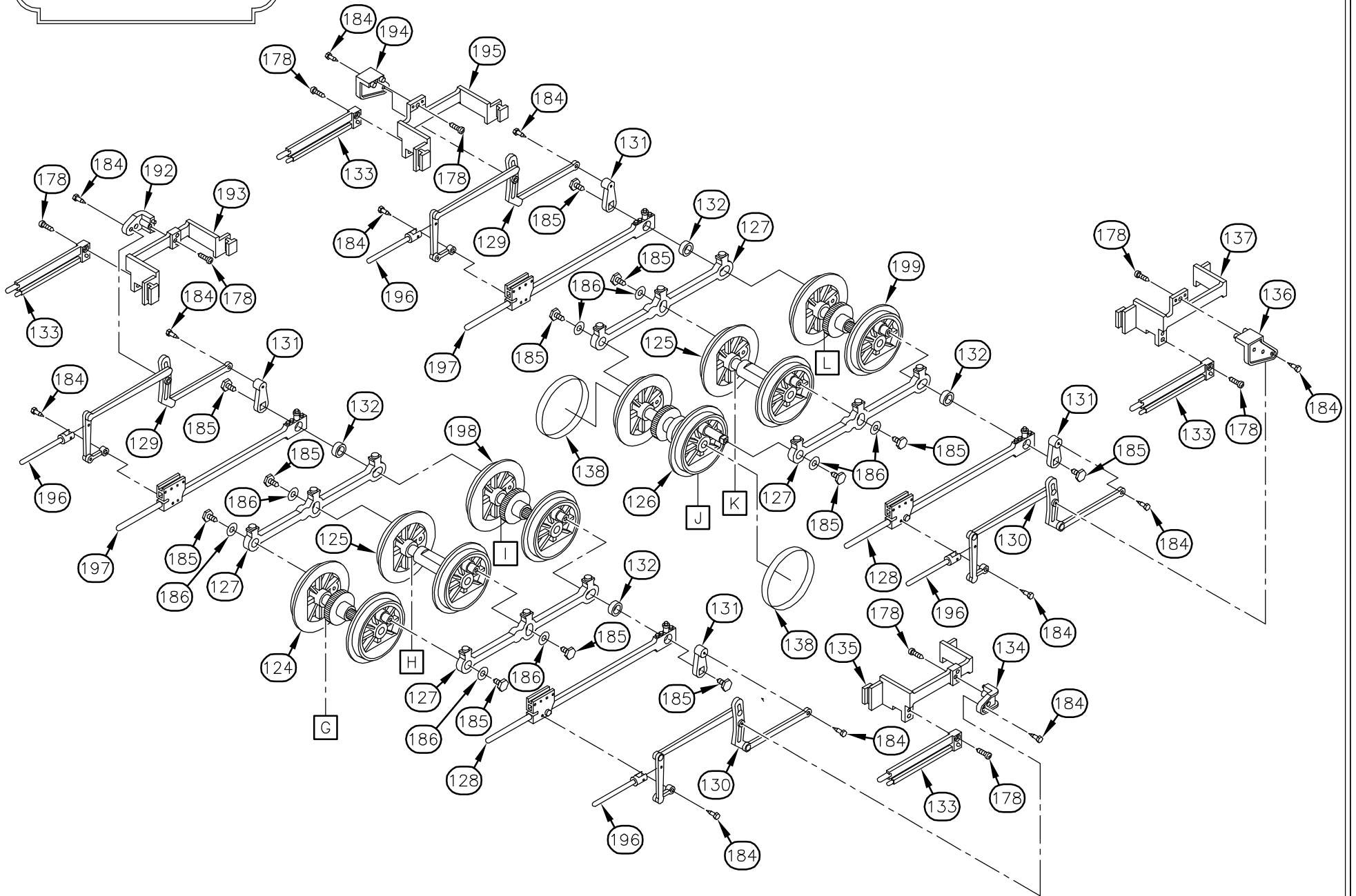



20892

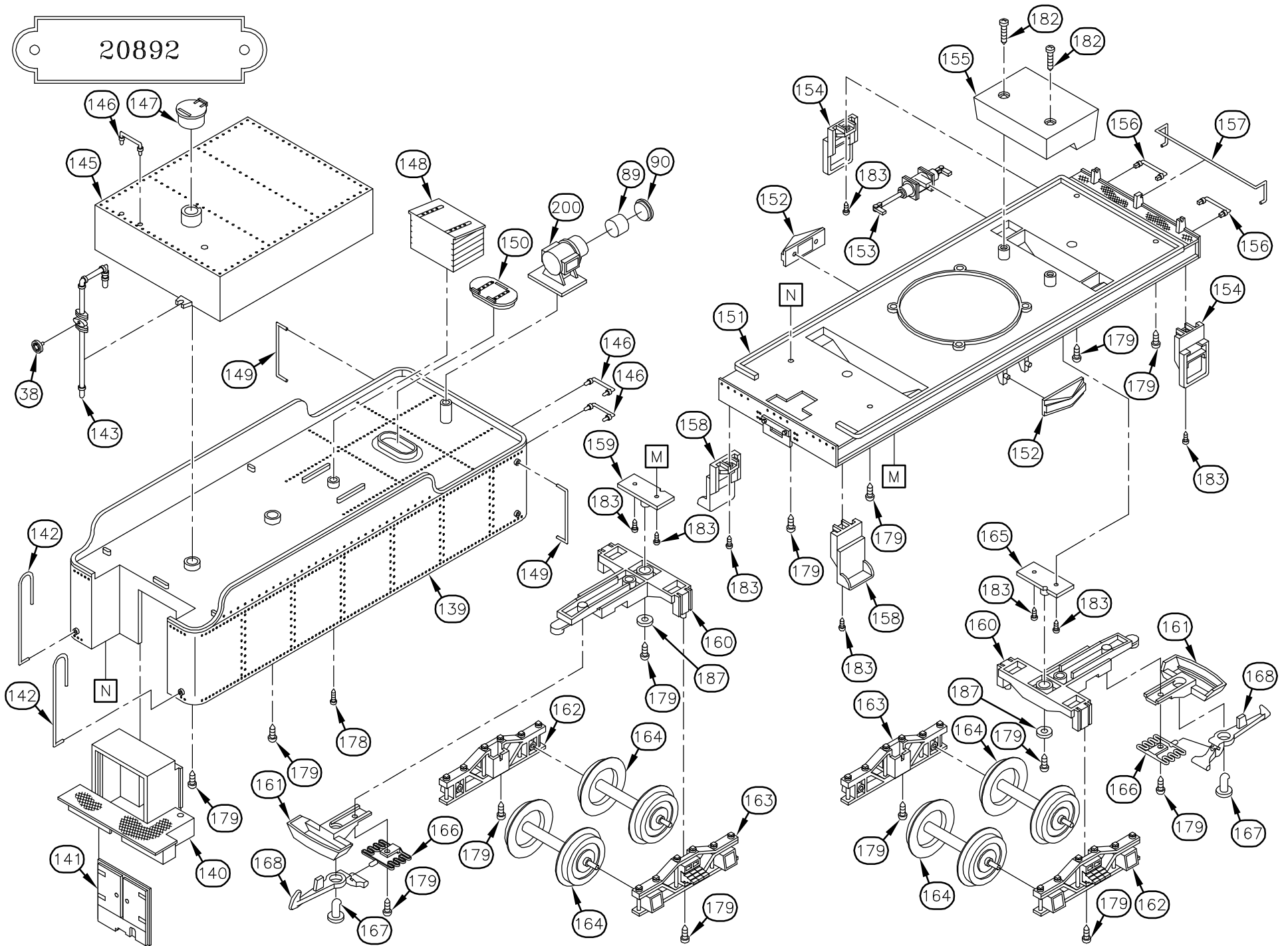

20892

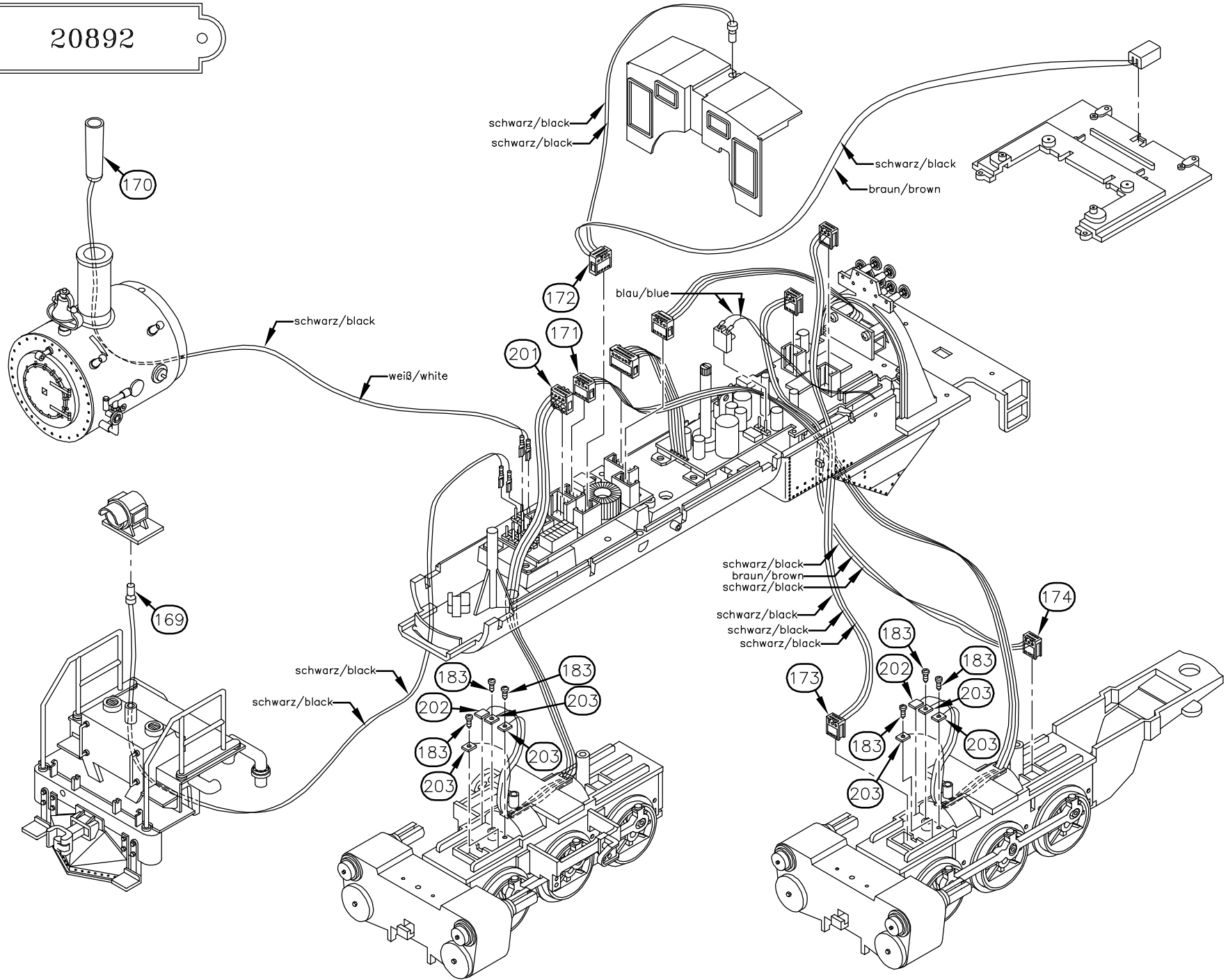

20892

